

**Z.R.E.**

... Infinite solutions ...

## **Ceramic insulated band heaters**



**MODEL Z.41 (CERAMIC)**

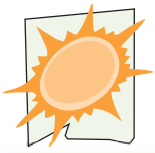

### Model Z.41 ceramic

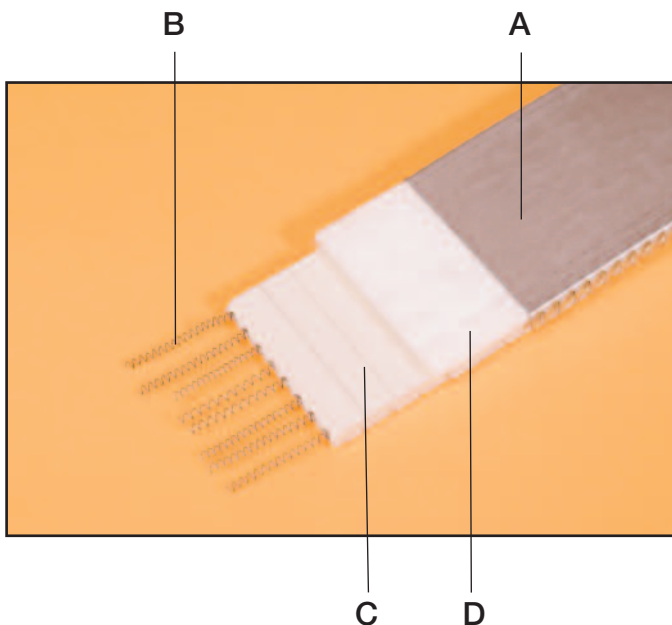

- (A) External stainless steel sheet
- (B) Resistive winding
- (C) High purity ceramic insulation
- (D) Ceramic fibre insulation

#### Technical features

##### Use

- Plasticization cylinders for injection molding machines or extruders
- Mica band heaters are the ideal solution for heating cylindrical surfaces in many other applications

##### Advantages of the ceramic band heaters

- Excellent heat exchange to the cylinder
- Heating uniformity
- Long life of the heater (when properly used)
- Easy to install
- High mechanical resistance
- Constant quality with time
- It is very important underlining that for this heater, heat exchange takes place both for conduction and radiation.
- Energy saving is an important characteristic because the ceramic fibre layer, placed between the ceramic and the external casing, reduces of about 20% energy consumption, if compared to a normal mica band heater.

##### Diameters

- Starting from 70mm, for heaters whose diameter is over 500mm is recommendable to manufacture them in two or more different sector with separate feedings

##### Widths

- In this case, widths are determined by the distance between the holes inside the ceramic blocks and, therefore, we have worked out the table at pag. 3 with the standard widths in mm.

##### Technical features

- Specific wattage up to 8 W/cm<sup>2</sup>
- Working temperature up to 420 °C
- External stainless steel sheet, resistant to high temperatures (A)
- Nickel-Chrome 80/20 resistive winding (B)
- High purity ceramic insulation (C)
- Ceramic fibre insulation (D)
- Heater's standard thickness 12 +/- 1mm
- Fibreglass insulated feeding cable with pure Ni or CuNi conductor externally protected by a metal braiding (built in earth wire) – working temperature 320°C , with peak 350°C.
- Options:
  - Pure Ni or CuNi conductors with silicon sleeve -max working (Temperature 180°C, peak 200°)

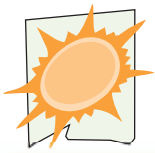

Over 300 mm diameter clamping screw with spring TCE M6 L100

CLAMP TYPE	Ø V	Ø G	Ø T	M	L
TCE M6 L100	M6	12	12	40	100

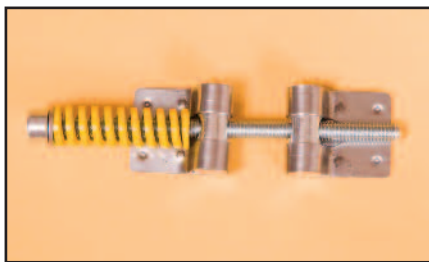
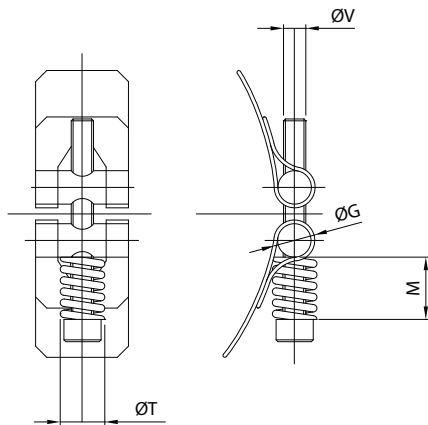

### Technical features

#### Feasible electric connections

- All monophasic voltages
- From 53mm width up to 121mm , it is possible to apply a star (Y) three phase feeding
- Over 121mm width it is possible to apply a star (Y) or delta (Δ) three phase feeding

#### Testing

- A sophisticated testing equipment (TPC 2000) allows us to guarantee the entire product, because all heaters are hot tested , applying their actual working voltage
- TPC 2000 is complete with a printer certifying testing results
- Testing certificate for each single heater, upon request

#### Standard measurements

- Ohmic Value
- Dielectric strength
- Current loss
- Insulation resistance
- Earth wire efficiency

For further information please contact our technical dep.

We reserve the right to change technical details.

## Standard width

Width (mm)										
20	65	110	156	201	246	291	336	381	426	471
28	73	118	164	209	254	299	344	389	434	479
35	80	125	171	216	261	306	351	396	441	486
43	88	133	179	224	269	314	359	404	449	494
50	95	140	186	231	276	321	366	411	456	501
58	103	148	194	239	284	329	374	419	464	509

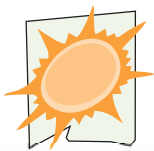

How to order

### Model Z.41

- Application: .....
- + Diameter D (mm): .....
- + Width L (mm): .....
- + Feeding voltage (V): .....
- + Wattage (W): .....

### Exit Box:

- + Type: (see brochure connections link):.....
- + Position from the edge (P): .....
- + Position as per pic. 1 (degrees): .....
- + Cable direction: axial (AX 1-2) - tangential (TX 1-2) - radial: .....
- + Cable length (mm): .....

### Thermocouple Holes and slot:

- + N° holes and slot: .....
- + Position as per pic. 1 (degrees): .....
- + Holes/slot Axis from the edge (U): .....
- + Holes' diameter (mm): .....
- + Any threaded connector (see pag 6): .....
- + Slot diameter (mm): .....
- + Any insulation covering:.....

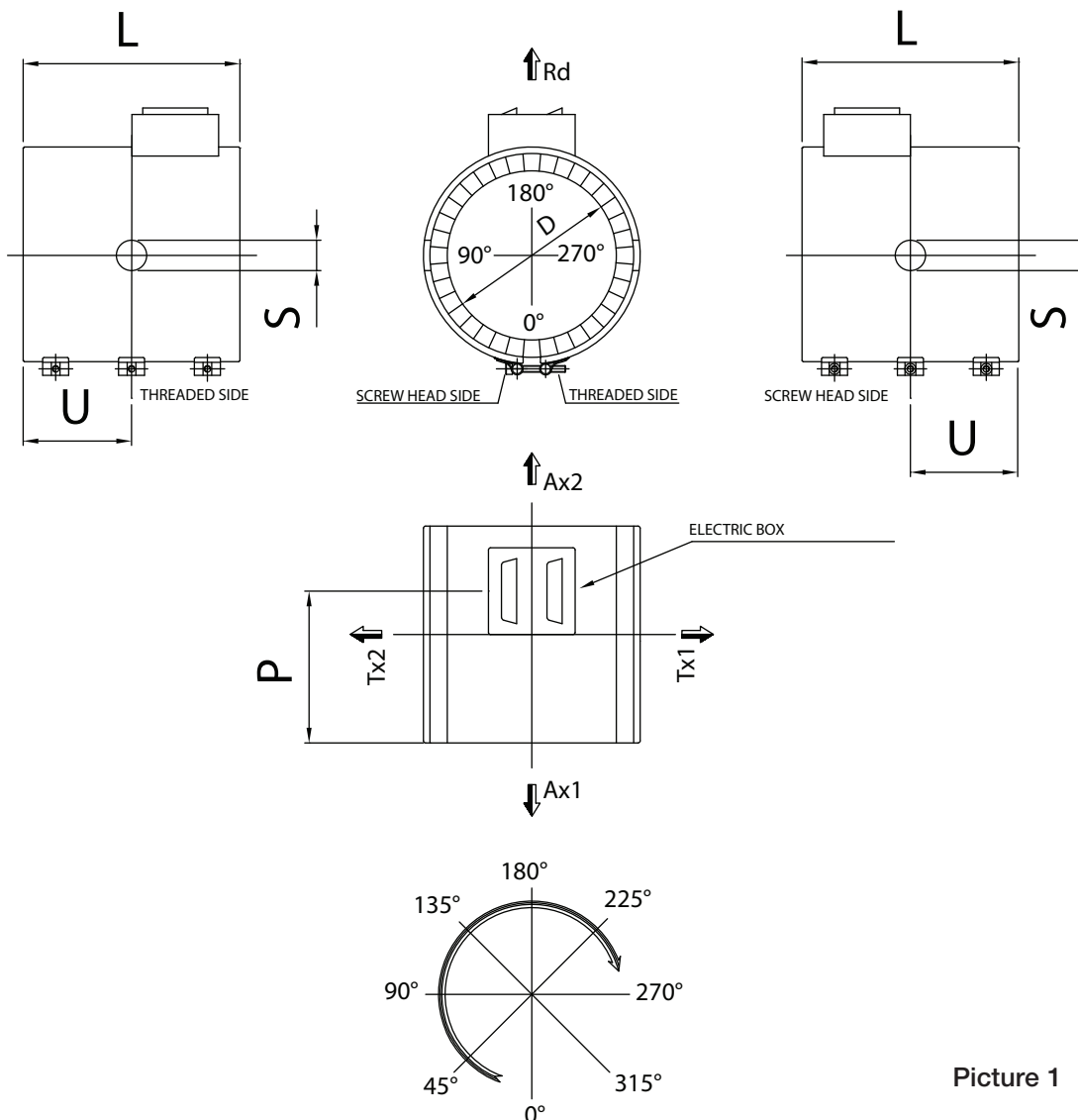

Picture 1

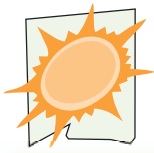

### Holes or slots

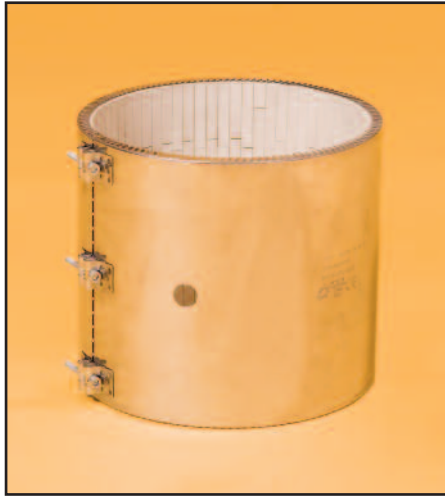

From width 30mm is possible to supply heaters with external thermocouple holes or slots.  
It's also possible to provide a threaded connector as showed in the picture

### Standard threaded connector



M8 x 1,25 (8MA)	M10 x 1,5 (10MA)	M10 x 1 (10MB)	M12 x 1,75 (12MA)	M12 x 1,5 (12MB)	M12 x 1 (12MC)
--------------------	---------------------	-------------------	----------------------	---------------------	-------------------

1/8" GAS	1/4" GAS	3/8" GAS
----------	----------	----------

### Special execution



**Modello Z.42**  
execution with single insulation covering

**Modello Z.43**  
execution with double insulation covering, inside insulated and outside with perforated sheet

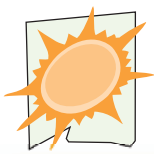

### Special execution

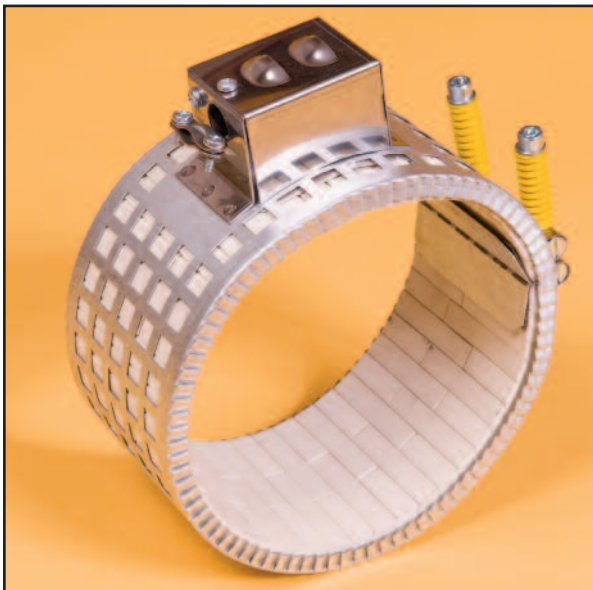

Heater bands model Z.41 with external perforated sheet for heat dispersion by forced ventilation



Heater bands model Z.41 with ceramic insulation with external perforated sheet. Finned dissipators (made of Al 20/10) and covering with coupling flange for blowers



### Connections

Please check all our connection option at the following link [www.zre.it](http://www.zre.it)

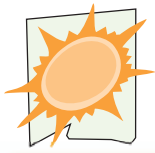

### Installation and storage instruction

#### Installation

- The particular flexible structure of this heater facilitates remarkably its application on the cylinder.

As a matter of fact, it is possible to enlarge the band far beyond its internal diameter, in order to tighten it on the cylinder with the suitable hexagonal cylindrical head screws. When installing the ceramic band heater, please make sure to hold it tightly screwing up the apposite bolts (with exagonal head). When reached the working temperature or after 30 min. heating screw it up still further. Do the same after few hours in order to compensate the thermal linear expansion of the heater.

Not doing the operation described above may cause the over heating of the parts of the heater that are not perfectly in contact with the nozzle pointed out by a colour change purple - black and consequently the resistive filament may burn.

**It is very important to follow these advices in order to have a longer lifetime of the heater**



#### Connections

- Protect connections against the ingress of liquids and gases to avoid short circuits
- Install the connections away from sharp edges or parts since this may also cause short circuits
- Protect connection leads against the effects of temperature and lay them in a proper way
- Pay attention to the connection voltage

#### Storage

- Store at room temperature in a dry place.

#### Operation

- Security procedures for the handling of electrical items and applications must be followed
- Do not touch ceramic heater bands while in use because they can get very hot
- Please make sure that the heating elements can not touch flammable material while in use

#### General information

- If our ceramic bands heater are delivered with feeding cables without insulation (naked connection) or with removable insulation (covered with gls-sleeving) the customer himself has to take care about the protection against electricity.

#### Temperature controllers

- Temperature controllers have to match the power consumption and the used temperature sensor.
- Only install temperature controllers with automatic soft start function so that any moisture which may have entered the heating element will escape slowly

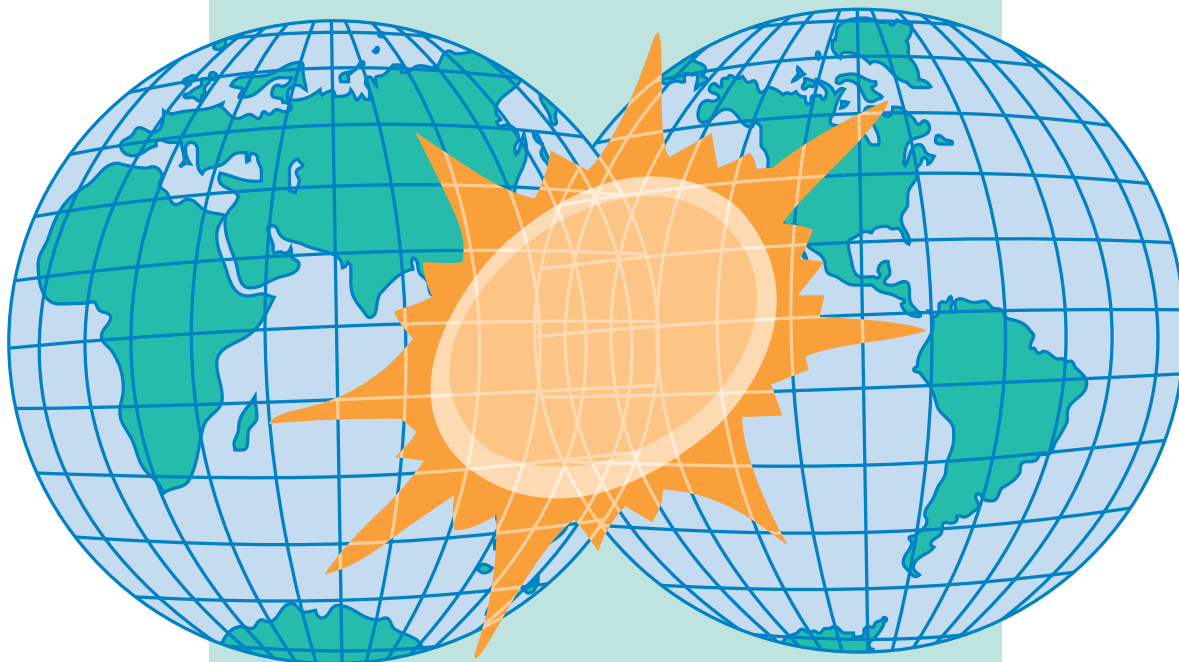

# Z.R.E.<sup>®</sup> s.r.l.

10040 San Gillio - Torino (Italy) - Via Druento, 48/2  
Tel. +390119841848 8 linee R.A. - Fax +390119848099  
e-mail: [info@zre.it](mailto:info@zre.it) [www.zre.it](http://www.zre.it)

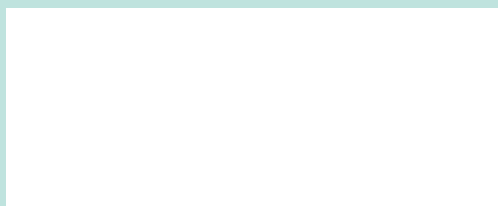

Marcatura  secondo direttiva 2006/95/CE del 11/12/2006